

## DS-2DF8A442IXG-F/SP 4MP 42X DarkFighter IR Network Speed



- 1/1.8" Progressive Scan CMOS
- High quality imaging with 4 MP resolution
- Excellent low-light performance with DarkFighter technology
- 42× optical zoom and 16× digital zoom provide close up views over expansive areas
- Expansive night view with up to 500 m IR distance
- Water and dust resistant (IP67) and vandal proof (IK10)
- Supports face capture to detect, capture, grade, and select faces in motion
- Supports road traffic to detect vehicles
- Smart Pan-Tilt Correction

## ▪ Specification

<b>Camera</b>	
Image Sensor	1/1.8" progressive scan CMOS
Min. Illumination	Color: 0.001 Lux @ (F1.2, AGC ON), B/W: 0.0005 Lux @ (F1.2 , AGC ON), 0 Lux with IR
Shutter Speed	1/1 s to 1/30,000 s
Slow Shutter	Yes
Day & Night	IR cut filter
Zoom	42x optical, 16x digital
Max. Resolution	2560 × 1440
<b>Lens</b>	
Focus	Auto, semi-auto, manual, rapid focus
Focal Length	6.0 mm to 252 mm
Zoom Speed	Approx. 4.5 s
FOV	Horizontal field of view: 56.6° to 1.7° (wide-tele), Vertical field of view: 33.7° to 0.9° (wide-tele), Diagonal field of view: 63.4° to 1.9° (wide-tele)
Aperture	Max. F1.2
<b>Illuminator</b>	
Supplement Light Type	IR
Supplement Light Range	500 m
Smart Supplement Light	Yes
<b>PTZ</b>	
Movement Range (Pan)	360°
Movement Range (Tilt)	-20° to 90° (auto flip)
Pan Speed	Pan speed: configurable from 0.1° to 210°/s; preset speed: 280°/s
Tilt Speed	Tilt speed: configurable from 0.1° to 150°/s, preset speed 250°/s
Proportional Pan	Yes
Presets	300
Patrol Scan	8 patrols, up to 32 presets for each patrol
Pattern Scan	4 pattern scans, record time over 10 minutes for each scan
Power-off Memory	Yes
Park Action	Preset, pattern scan, patrol scan, auto scan, tilt scan, random scan, frame scan, panorama scan
3D Positioning	Yes
PTZ Status Display	Yes
Preset Freezing	Yes
Scheduled Task	Preset, pattern scan, patrol scan, auto scan, tilt scan, random scan, frame scan, panorama scan, dome reboot, dome adjust, aux output
<b>Video</b>	
Main Stream	50 Hz: 25 fps (2560 × 1440, 1920 × 1080, 1280 × 960, 1280 × 720) 60 Hz: 30 fps (2560 × 1440, 1920 × 1080, 1280 × 960, 1280 × 720)
Sub-Stream	50 Hz: 25 fps (704 × 576, 640 × 480, 352 × 288) 60 Hz: 30 fps (704 × 480, 640 × 480, 352 × 240)

Third Stream	50 Hz: 25 fps (1920 × 1080, 1280 × 960, 1280 × 720, 704 × 576, 640 × 480, 352 × 288) 60 Hz: 30 fps (1920 × 1080, 1280 × 960, 1280 × 720, 704 × 480, 640 × 480, 352 × 240)
Video Compression	Main stream: H.265+/H.265/H.264+/H.264 Sub-stream: H.265/H.264/MJPEG Third stream: H.265/H.264/MJPEG
Video Bit Rate	32 Kbps to 16384 Kbps
H.264 Type	Baseline Profile/Main Profile/High Profile
H.265 Type	Main Profile
Scalable Video Coding (SVC)	H.264 and H.265 encoding
Region of Interest (ROI)	8 fixed regions for each stream
<b>Audio</b>	
Audio Compression	G.711alaw, G.711ulaw, G.722.1, G.726, MP2L2, PCM
Audio Bit Rate	64 Kbps (G.711)/16 Kbps (G.722.1)/16 Kbps (G.726)/32 to 192 Kbps (MP2L2)
<b>Network</b>	
Network Storage	NAS (NFS, SMB/ CIFS), ANR
Protocols	IPv4/IPv6, HTTP, HTTPS, 802.1x, Qos, FTP, SMTP, UPnP, SNMP, DNS, DDNS, NTP, RTSP, RTCP, RTP, TCP/IP, DHCP, PPPoE, UDP, IGMP, ICMP, Bonjour
API	ISUP, ISAPI, Hikvision SDK, Open Network Video Interface (Profile S, Profile G, Profile T)
Simultaneous Live View	Up to 20 channels
User/Host	Up to 32 users. 3 levels: Administrator, Operator and User
Security	Password protection, complicated password, HTTPS encryption, 802.1X authentication (EAP-TLS, EAP-LEAP, EAP-MD5), watermark, IP address filter, basic and digest authentication for HTTP/HTTPS, RTP/RTSP over HTTPS, control timeout settings, security audit log, TLS 1.3, host authentication (MAC address)
Client	HikCentral, iVMS-4200, Hik-Connect
Web Browser	IE11, Chrome 57.0+, Firefox 52.0+, Safari 11+
<b>Image</b>	
Image Settings	Saturation, brightness, contrast, sharpness, gain, and white balance adjustable by client software or web browser
Day/Night Switch	Day, night, auto, scheduled-switch
Image Enhancement	BLC, HLC, 3D DNR
Wide Dynamic Range (WDR)	140 dB WDR
Defog	Optical defog
Image Stabilization	Yes. Built-in gyroscope to improve EIS performance.
Regional Exposure	Yes
Regional Focus	Yes
Privacy Mask	Up to 24 masks, polygon region, mosaic mask, mask color configurable
SNR	≥ 52 dB
<b>Supplement Detection</b>	
Satellite Positioning	Yes
Compass	Yes
<b>Interface</b>	
Ethernet Interface	1 RJ45 10M/100M self-adaptive Ethernet port
Fiber Optical	FC interface, built-in fiber module (100 M, TX1310/RX1550nm wavelength, single module fiber, up to 20 km transmission distance)
On-board Storage	Built-in memory card slot, support MicroSD/MicroSDHC/MicroSDXC, up to 256 GB

Alarm	7 inputs, 2 outputs
Audio	1 input (line in), max. input amplitude: 0-3.3Vpp, input impedance: 4.7KΩ±5%; 1 output (line out), line level, output impedance: 600 Ω
Video Output	1.0V[p-p]/75Ω, PAL, NTSC, BNC connector
RS-485	HIKVISION, Pelco-P, Pelco-D, self-adaptive
<b>Event</b>	
Basic Event	Motion detection, video tampering alarm, alarm input and output, exception
Smart Event	Line crossing detection, region entrance detection, unattended baggage detection, object removal detection, intrusion detection, region exiting detection, vandal-proof alarm, audio exception detection
Smart Tracking	Manual tracking, auto-tracking
Alarm Linkage	Alarm actions, such as Preset, Patrol Scan, Pattern Scan, Memory Card Video Record, Trigger Recording, Notify Surveillance Center, Upload to FTP/Memory Card/NAS, Send Email, etc.
<b>Deep Learning Function</b>	
Face Capture	Support detecting up to 30 faces at the same time. Support detecting, tracking, capturing, grading, selecting of face in motion, and output the best face picture of the face
Face Comparison	Yes
Perimeter Protection	Line crossing, intrusion, region entrance, region exiting Support alarm triggering by specified target types (human and vehicle)
<b>Road Traffic and Vehicle Detection</b>	
Road Traffic	Support vehicle detection (license plate number, vehicle model, and vehicle color recognition)
<b>General</b>	
General Function	Mirror, password protection, watermark, IP address filter
Power	24 VAC (Max. 60 W, including max. 18 W for IR and max. 6 W for heater)
Operating Condition	Temperature: -40°C to 70°C (-40°F to 158°F), Humidity: ≤ 95%
Dimension	∅ 267 mm × 405 mm (∅ 10.51" × 15.94")
Weight	Approx. 8.5 kg (18.74 lb.)
Language	33 languages: English, Russian, Estonian, Bulgarian, Hungarian, Greek, German, Italian, Czech, Slovak, French, Polish, Dutch, Portuguese, Spanish, Romanian, Danish, Swedish, Norwegian, Finnish, Croatian, Slovenian, Serbian, Turkish, Korean, Traditional Chinese, Thai, Vietnamese, Japanese, Latvian, Lithuanian, Portuguese (Brazil), Ukrainian
<b>Approval</b>	
EMC	FCC SDoC (47 CFR Part 15, Subpart B); CE-EMC (EN 55032: 2015, EN 61000-3-2: 2019, EN 61000-3-3: 2013, EN 50130-4: 2011 +A1: 2014); RCM (AS/NZS CISPR 32: 2015); IC VoC (ICES-003: Issue 6, 2019); KC (KN 32: 2015, KN 35: 2015)
Safety	UL (UL 62368-1) CB (IEC 60950-1:2005 + Am 1:2009 + Am 2:2013, IEC 62368-1:2014); CE-LVD (EN 62368-1:2014+A11:2017), BIS (IS 13252(Part 1):2010+A1:2013+A2:2015); LOA (SANS IEC60950-1)

Environment	CE-RoHS (2011/65/EU); WEEE (2012/19/EU); Reach (Regulation (EC) No 1907/2006)
Protection	IP67 Standard, Lightning Protection, Surge Protection and Voltage Transient Protection, ±6kV Line to Gnd, ±3kV Line to Line, IEC61000-4-5, IK10

### ▪ Available Model

DS-2DF8A442IXG-F/SP



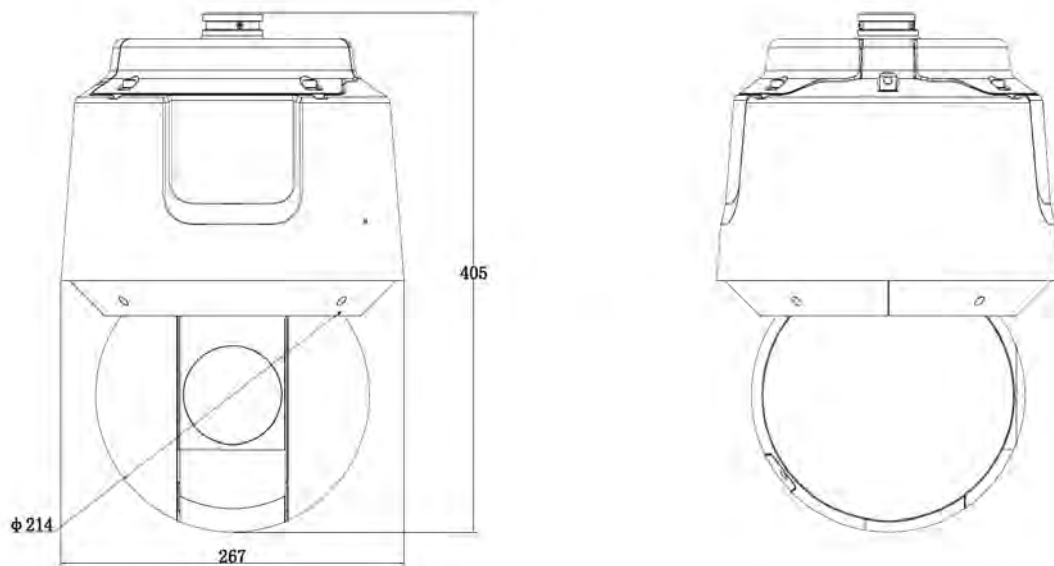











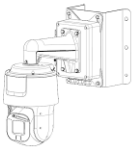

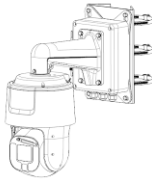
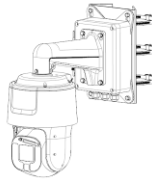

### ▪ Dimension

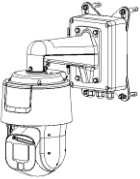
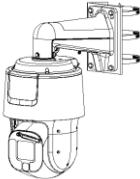
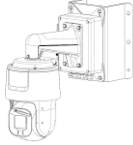

### Accessory

#### ▪ Optional

DS-1660ZJ-P Wall mount	DS-1604ZJ-Corner-P Corner mount	DS-1673ZJ-P Vertical pole mount	DS-1604ZJ-P Wall mount	DS-1604ZJ-Pole-P Vertical pole mount

<b>DS-4660ZJ-PC</b>	<b>DS-1673ZJ-P</b> <b>Vertical pole mount</b>	<b>DS-1604ZJ-BOX-PO</b> <b>LE-P</b> <b>Vertical pole mount</b>	<b>DS-4650ZJ-PC</b>	<b>DS-1662ZJ-P</b> <b>Pendant Mount</b>
				
				
<b>DS-1674ZJ-P</b>	<b>DS-1684ZJ-P</b>	<b>DS-1604ZJ-BOX-CO</b> <b>RNER-P</b> <b>Wall mount</b>	<b>DS-1663ZJ-P</b> <b>In-ceiling mount</b>	<b>DS-1673ZJ-P</b> <b>Vertical pole mount</b>
				
				
<b>DS-1604ZJ-BOX-P</b> <b>Wall mount</b>	<b>DS-1661ZJ-P</b> <b>Pendant Mount</b>	<b>DS-1667ZJ-P</b> <b>Pendant Mount</b>	<b>DS-1602ZJ-P</b> <b>Wall Mount</b>	
				

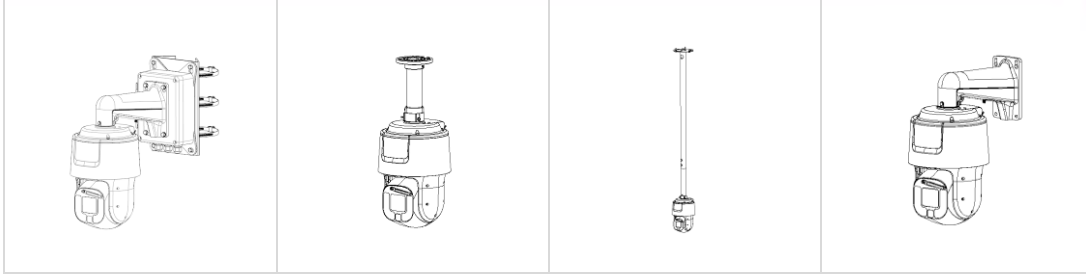

**Headquarters**

No.555 Qianmo Road, Binjiang District,  
Hangzhou 310051, China  
T +86-571-8807-5998  
www.hikvision.com



Follow us on social media to get the latest product and solution information.

